

 **FUJIFILM**

GA645 / GA645W

Professional Professional



OWNER'S MANUAL
BEDIENUNGSANLEITUNG
MODE D'EMPLOI
MANUAL DE INSTRUCCIONES
使用説明書

NAMES OF PARTS / BEZEICHNUNG DER TEILE / NOMENCLATURE / NOMENCLATURA / 部件名稱

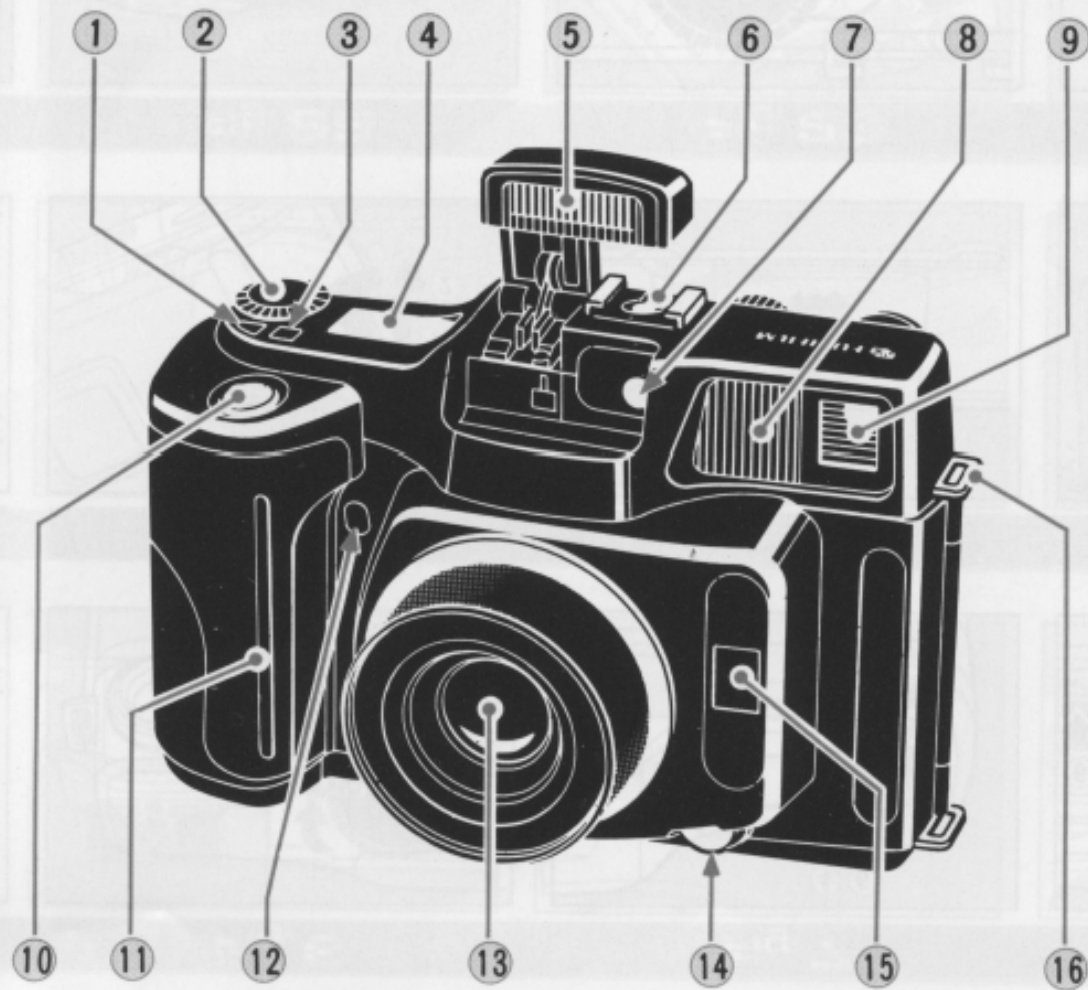

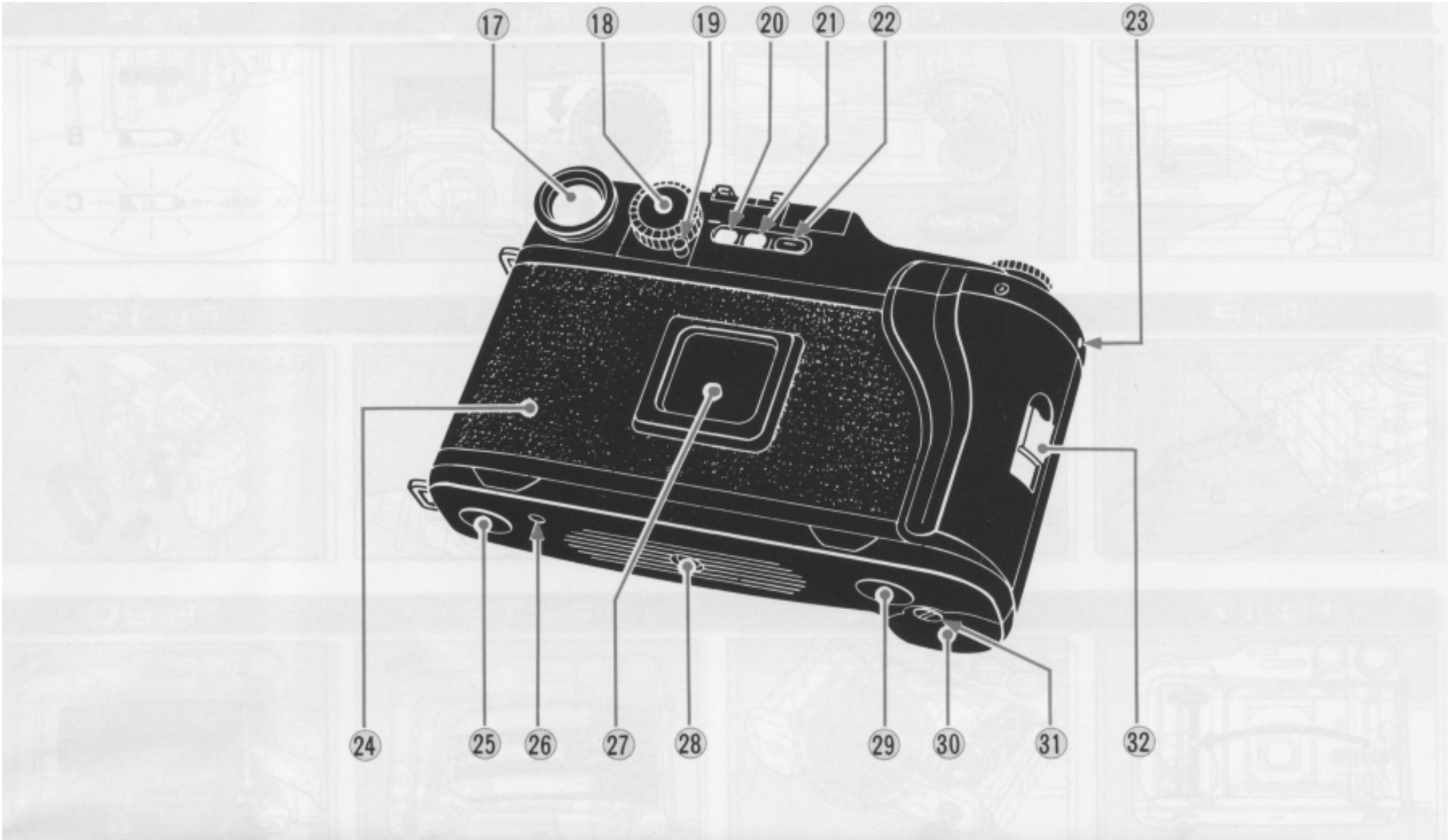

Liquid-crystal Display
Flüssigkristallanzeige
Affichage à cristaux liquides
Visualización de cristal líquido
液晶顯示屏

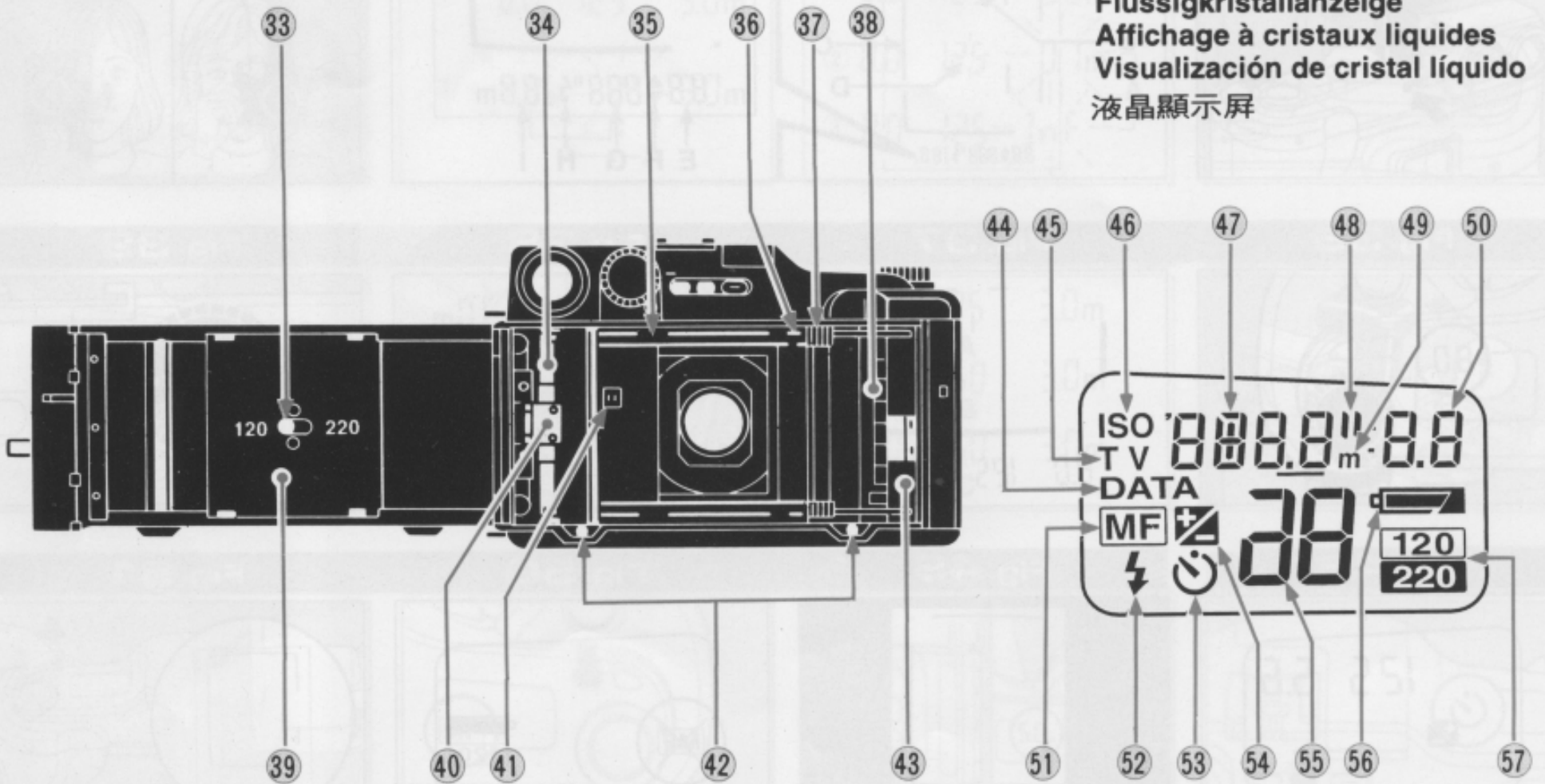

Fig. 1

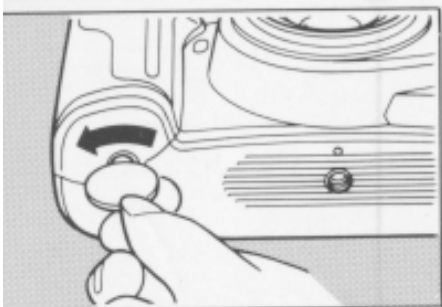

Fig. 2

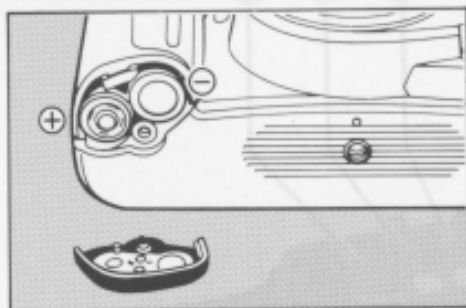

Fig. 3

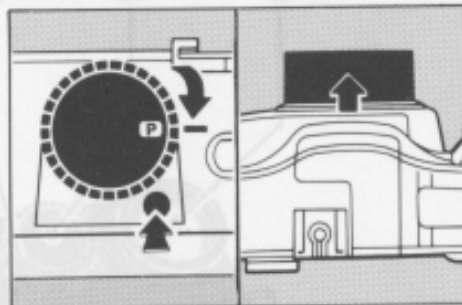

Fig. 4

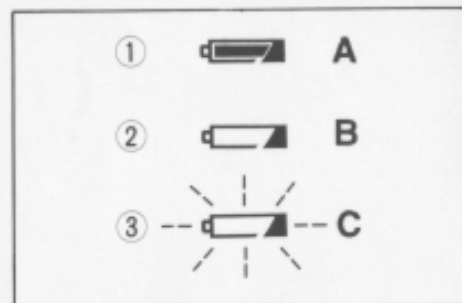

Fig. 9

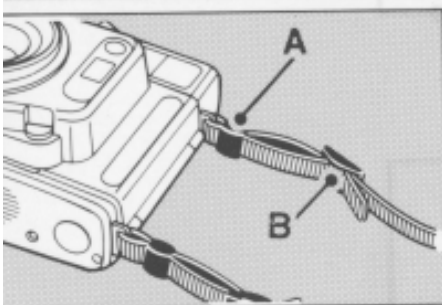

Fig. 10

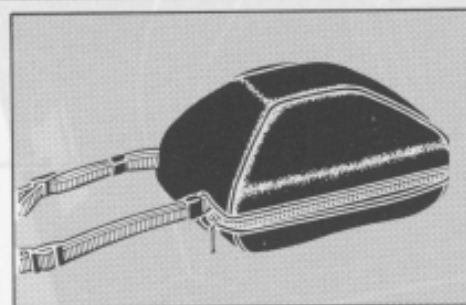

Fig. 11

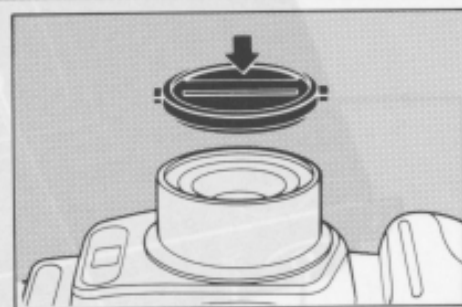

Fig. 12

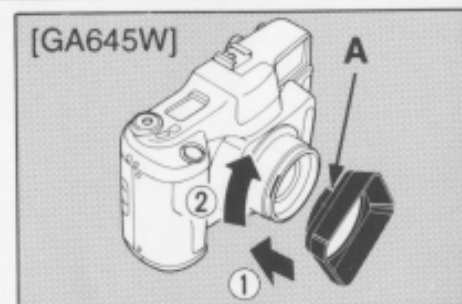

Fig. 17

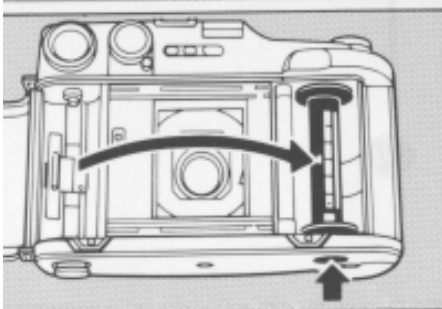

Fig. 18

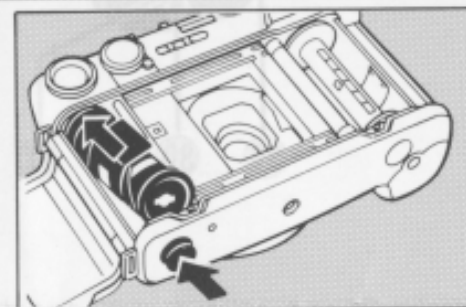

Fig. 19

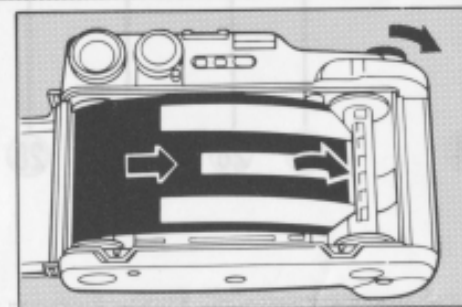

Fig. 20

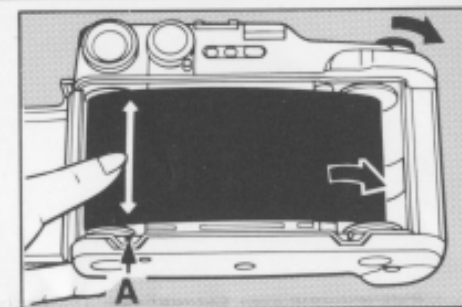

Fig. 5

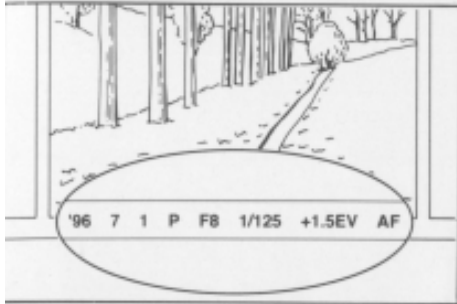

Fig. 6

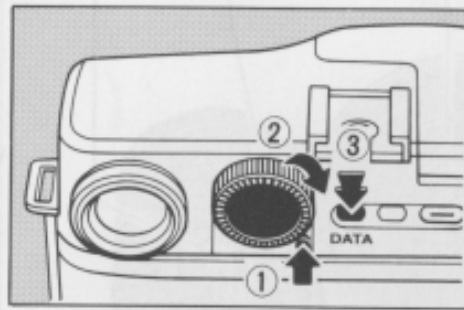

Fig. 7

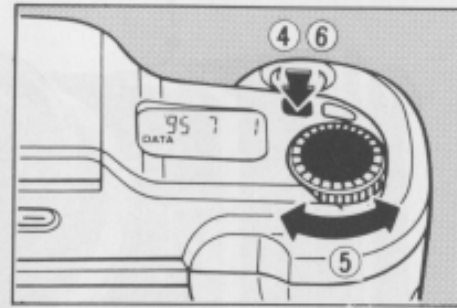

Fig. 8

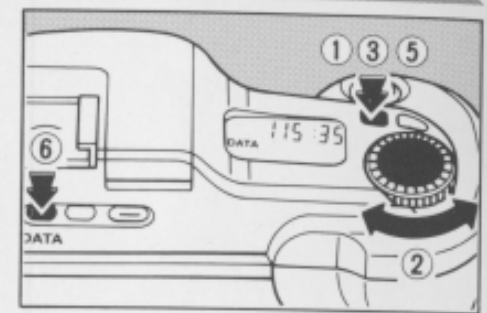

Fig. 13

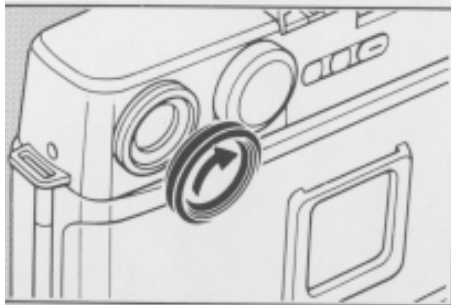

Fig. 14

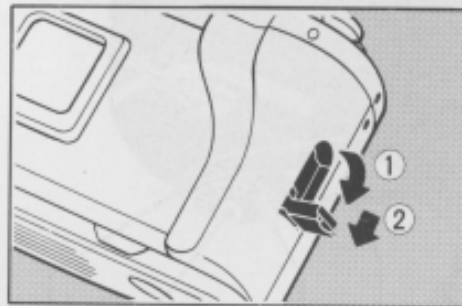

Fig. 15

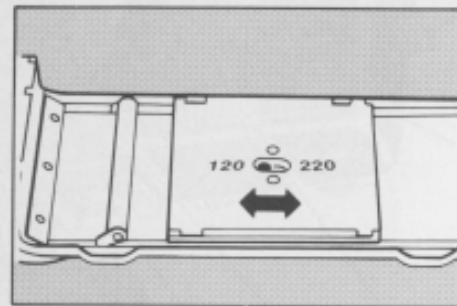

Fig. 16

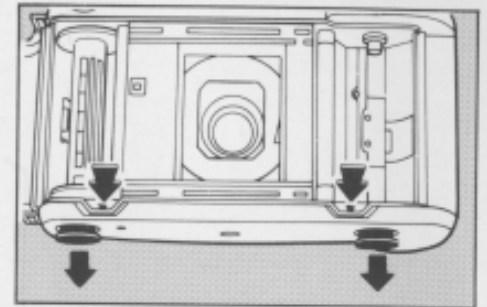

Fig. 21

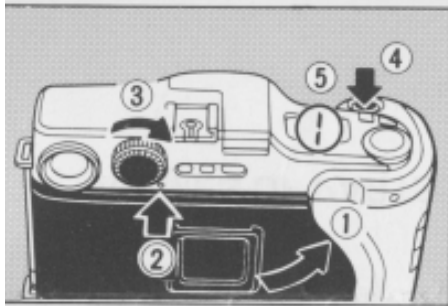

Fig. 22

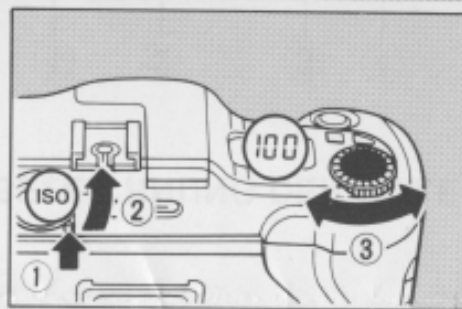

Fig. 23

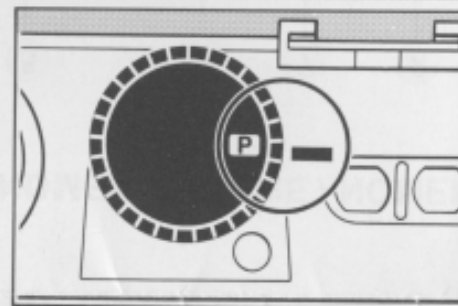

Fig. 24

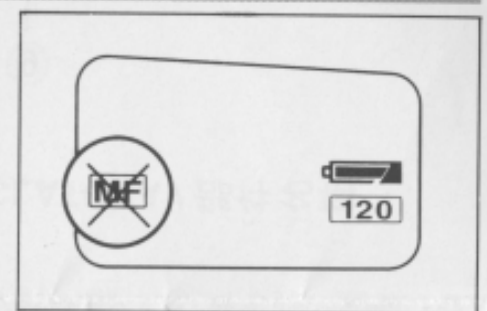

Fig. 25

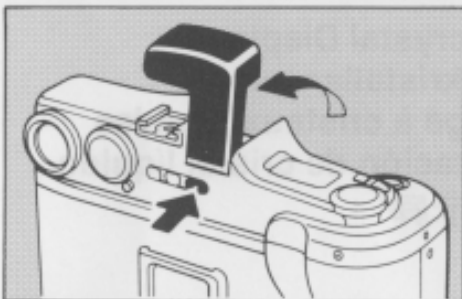

Fig. 26

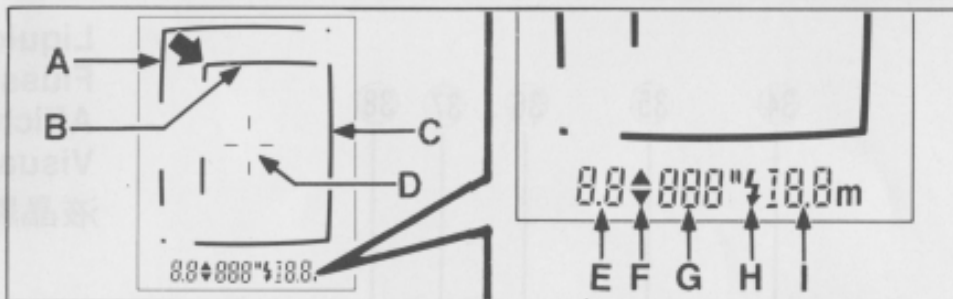

Fig. 27

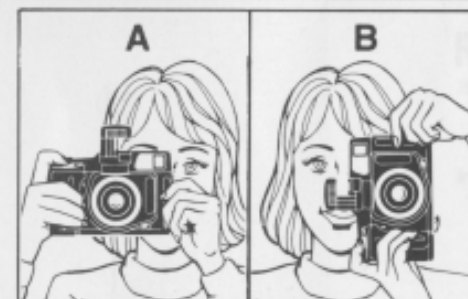

Fig. 36

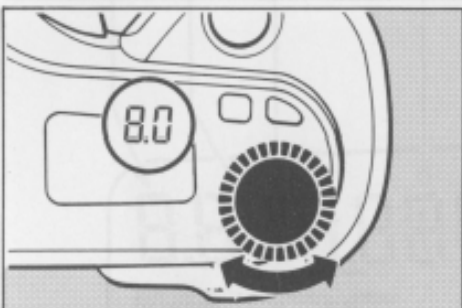

Fig. 37

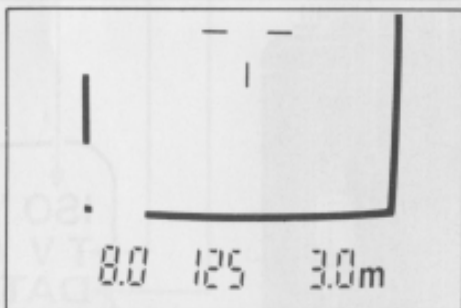

Fig. 38

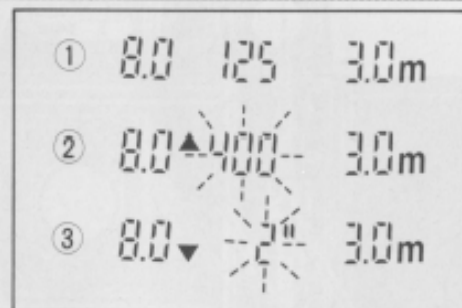

Fig. 39

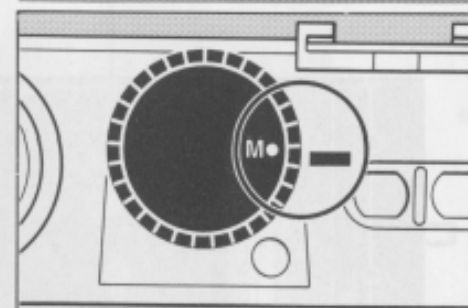

Fig. 48

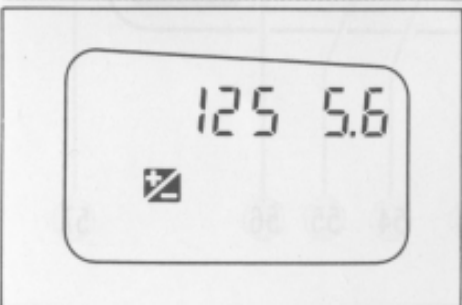

Fig. 49

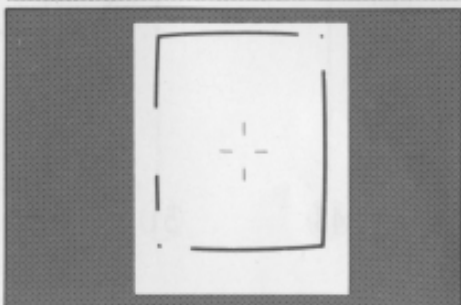

Fig. 50

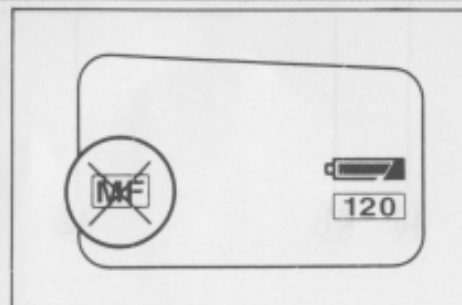

Fig. 51

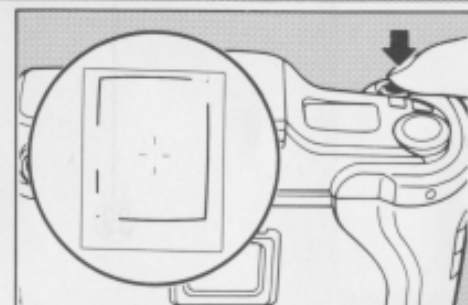

Fig. 28



Fig. 29

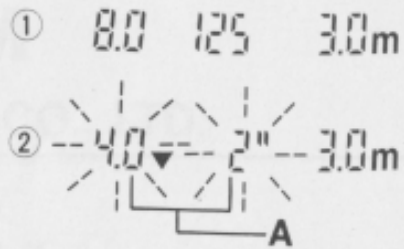

Fig. 30

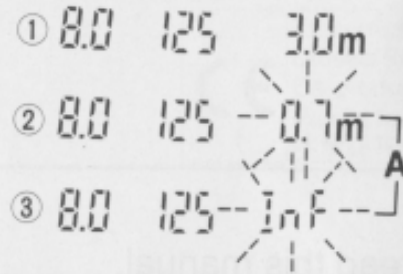

Fig. 31

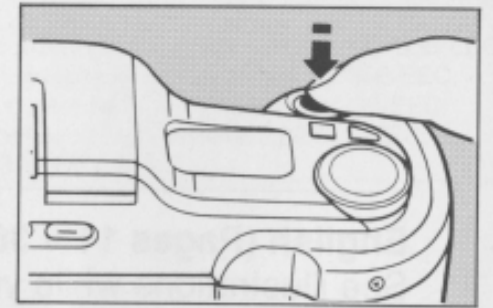

Fig. 40

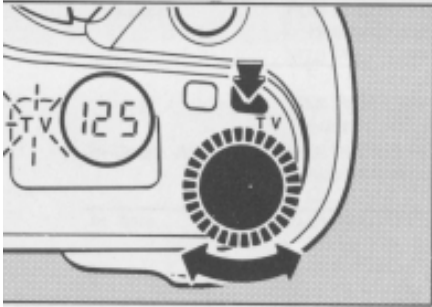

Fig. 41

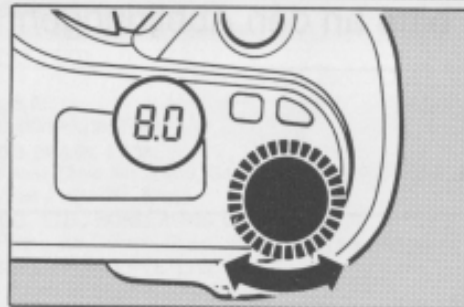

Fig. 42

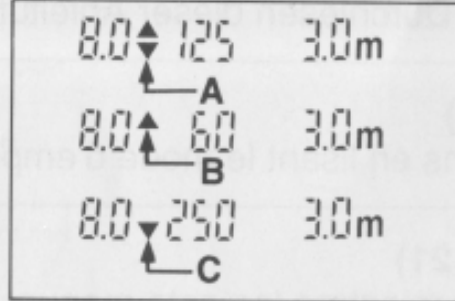

Fig. 43

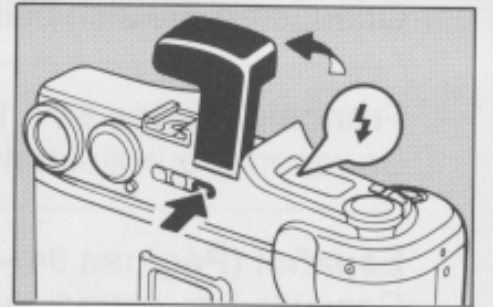

Fig. 52

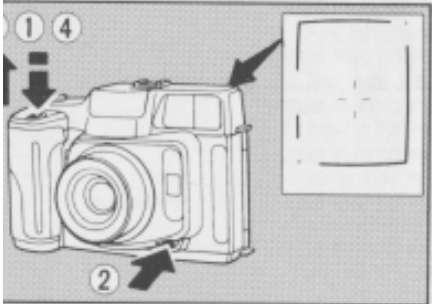

Fig. 53

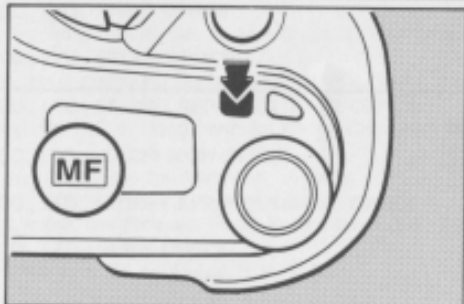

Fig. 54

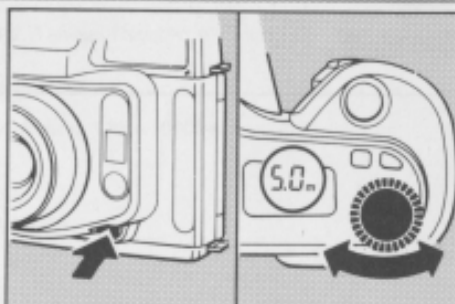

Fig. 55

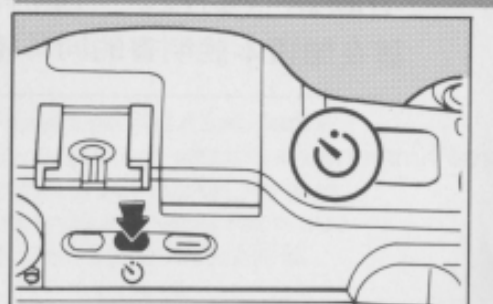

Fig. 32

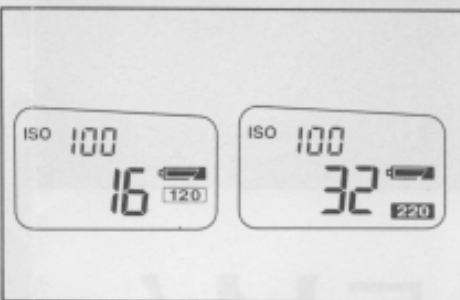

Fig. 33

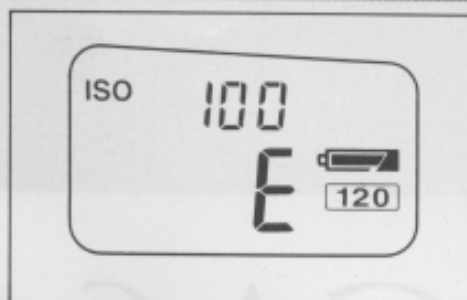

Fig. 34

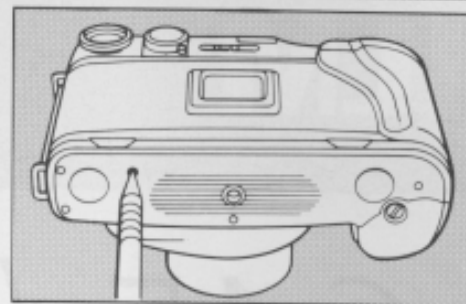

Fig. 35

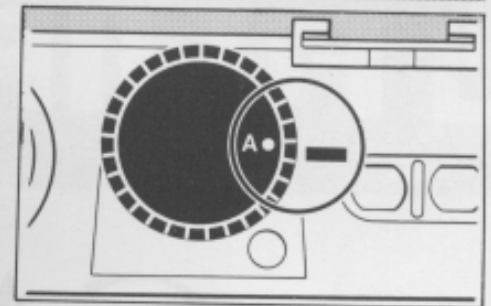

Fig. 44

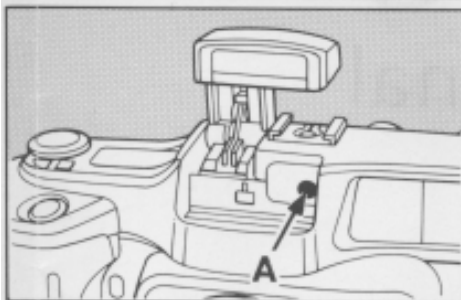

Fig. 45

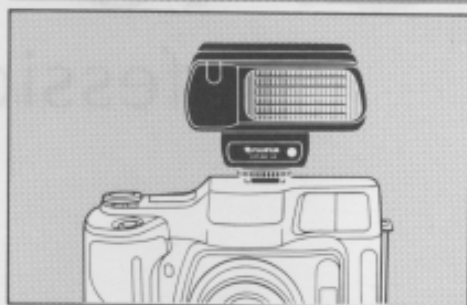

Fig. 46

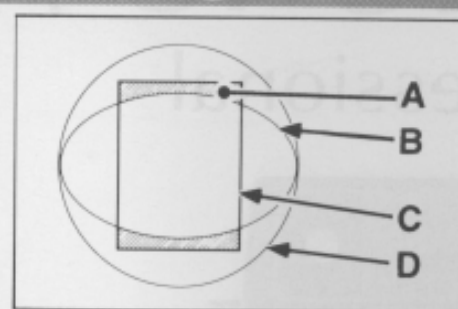

Fig. 47

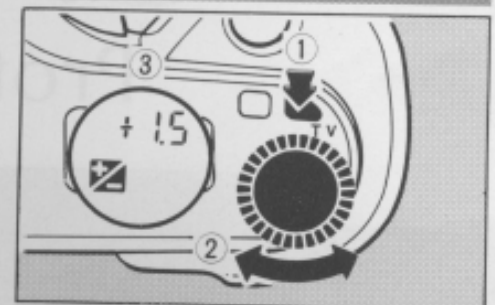

Fig. 56

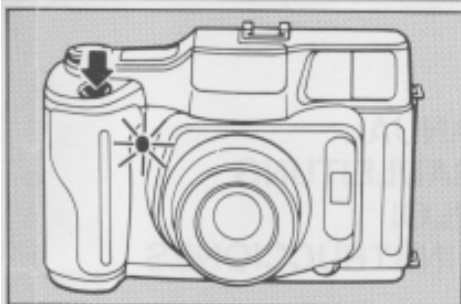

Fig. 57

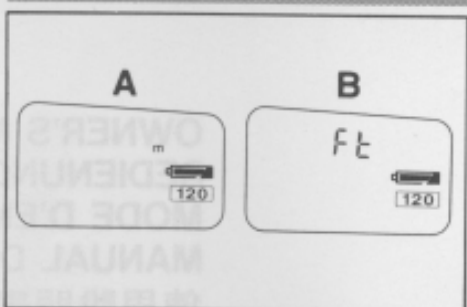

Fig. 58

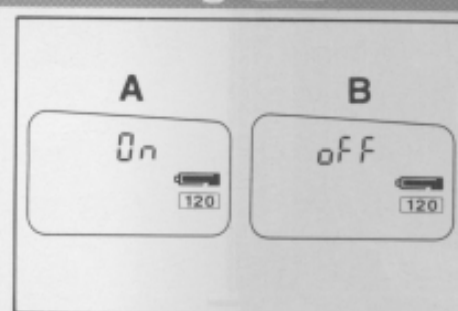
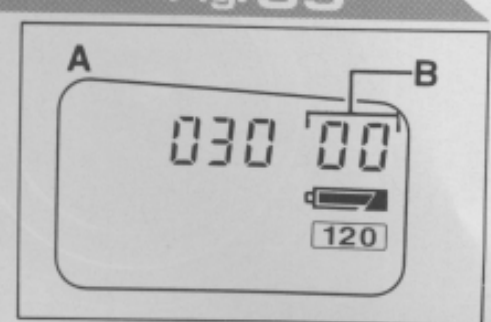

Fig. 59



This manual will show you how to use your camera correctly. Please follow the instructions carefully. For your information the operational methods of GA645 and GA645W are the same, the only difference between them is their focal distance. We have made an operational manual applicable to both models.

CONTENTS

Names of parts	11
Description of the functions of parts	12
Camera care and cautions	13
Special features	15
Specifications	15
I. Readyng the camera	17
Loading the batteries	17
Display and printing of data	18
Attaching the accessories	20
Loading the film	21
II. Basic procedures	23
Taking automatic-mode (autofocus/programmed auto exposure/automatic flash) pictures	23
Unloading the film	26
III. Advanced techniques	26
Aperture-priority auto exposure	26
Manual exposure	27

Using the built-in flash	28
Using an external flash	30
Exposure compensation	30
Using the focus lock	31
Manual focusing	32
Using the self-timer	33
IV. Extra functions	33
V. A word on the camera's autofocus system	34
Reference data	35

NAMES OF PARTS

- ① Exposure Compensation Button
- ② Up/Down Dial
- ③ Autofocus Button
- ④ Liquid Crystal Display
- ⑤ Flash Head
- ⑥ Hot-shoe
- ⑦ Flash Sensor
- ⑧ Finder Light Intake Window
- ⑨ Finder Window (also serves as an AE light receptor)
- ⑩ Shutter Release
- ⑪ Camera Grip
- ⑫ Self-timer Lamp
- ⑬ Lens
- ⑭ Manual Focusing Button
- ⑮ Autofocus Window
- ⑯ Strap Lug
- ⑰ Finder Eyepiece

- ⑱ Selecting Dial
- ⑲ Dial Lock Release
- ⑳ Data Button (DATA)
- ㉑ Self-timer Button (⌚)
- ㉒ Flash Button (⚡)
- ㉓ Cable Release Socket
- ㉔ Camera Back
- ㉕ Film Loading Knob
- ㉖ Mid-roll Wind-up Button
- ㉗ Film Reminder Slot
- ㉘ Tripod Socket
- ㉙ Spool Loading Knob
- ㉚ Battery Compartment Cover
- ㉛ Battery Compartment Cover Screw
- ㉜ Camera Back Lock
- ㉝ Pressure Plate Positioning Pin
- ㉞ Film Feed Chamber
- ㉟ Focal Plane Rail
- ㊱ Data Printing Window
- ㊲ Film Wind Sensing Roller
- ㊳ Spool
- ㊴ Pressure Plate
- ㊵ Spool Pressure Spring
- ㊶ Film Sensor
- ㊷ Spool Shaft Buttons
- ㊸ Film Take-up Chamber

Liquid Crystal Display (LCD)

This illustration shows all signs and indicators displayed in the LCD. Usually, only the information needed for each shot is displayed.

- ④④ Data Printing Sign
- ④⑤ Exposure Indicator
- ④⑥ Film Speed Sign
- ④⑦ Shutter Speed/Shooting Distance/Exposure Compensation/Film Speed Indicator
- ④⑧ Seconds
- ④⑨ Distance Unit Sign (m)
- ⑤⑩ F-number
- ⑤① Manual Focusing Mode Sign (If this sign does not appear, the camera is set for autofocus)
- ⑤② Flash Sign
- ⑤③ Self-timer Mode Sign
- ⑤④ Exposure Compensation Mode Sign
- ⑤⑤ Exposure Counter
- ⑤⑥ Battery Sign
- ⑤⑦ Film Type Indicator

DESCRIPTION OF THE FUNCTIONS OF PARTS

● Selecting Dial

- (1) OFF: Power off — Set it to OFF when not using the camera.
- (2) P: Programmed auto exposure — For setting exposure (aperture and shutter speed) auto-

atically.

- (3) A : Aperture-priority auto exposure — If you set the aperture, the shutter speed is set automatically.
- (4) M : Manual exposure — You can set your desired aperture and shutter speed.
- (5) ISO : To set the film speed, use this dial and the Up/Down Dial.

● Up/Down Dial

This dial has the following functions:

- (1) Feeding of the film leader when loading film.
- (2) Aperture setting in the aperture-priority auto exposure mode.
- (3) Setting of aperture and shutter speed in the manual exposure mode.
- (4) Setting of the film speed (ISO).
- (5) Setting of the shooting distance in the manual focusing mode.
- (6) Setting of the exposure compensating value (+/- EV) in the exposure compensation mode.
- (7) Setting of the date and time.

● Autofocus Button

For selecting the autofocus or manual focusing mode.

● Manual Focusing Button

- (1) In the manual focusing mode, use it with the Up/Down Dial for setting the shooting distance.
- (2) In the autofocus mode, use it to lock the focus.

● Exposure Compensation Button (+/-)

- (1) To compensate exposure, use it with the Up/Down

Dial.

- (2) To choose a shutter speed for manual exposure, use it with the Up/Down Dial.

● Data Button (DATA)

For selecting the data format (date, time, and exposure data).

● Self-timer Button (⏱)

For setting the self-timer mode.

● Flash Button (⚡)

For popping up and turning on the flash.

CAMERA CARE AND CAUTIONS

Your camera is a precision instrument. When handling it, take sufficient care and observe the following instructions.

1. Cleaning the camera

- Do not use solvents, such as thinner and alcohol, to clean your camera.
- Make it a habit to clean the camera before and after taking pictures. To clean it, dust off with an air blower and wipe the camera exterior with a soft cloth such as silicon cloth.
- Dust and soil inside the film chamber may damage your film. Take particular care to clean the camera interior.

2. Cleaning the lens

- Scratches on the lens surface can reduce its sharpness far more than you would think. If the contrast of your picture seems somehow insufficient and it does not look

crisp enough, the possible cause is scratches on the lens surface. Clean the lens carefully in the procedure described below.

- ① Set the Selecting Dial to OFF.
 - ② Blow off dust and debris from the lens surface with an air blower.
 - ③ Moisten a sheet of lens cleaning paper with a commercially available lens cleaning fluid and wipe the lens gently with it in a circular motion. Always start from the center then gradually move out to the edges.
 - ④ Finally, after all contaminants have been removed, wipe off the remaining lens cleaning fluid with a dry sheet of lens cleaning paper. Again, start from the center in a circular motion then move out to the edges.
- Breathing a mist on the lens surface then wiping it with silicon cloth or other similar material is the worst thing you can do. Never do it because this is one of the main causes of scratches on camera lenses.
 - Clean the Autofocus Window and Finder in the same way as described above for the lens. Scratches on the Autofocus Window can cause incorrect focusing.

3. Liquid crystal display

- Though the liquid crystal display may sometimes look black at a high temperature around 60°C, it will return to normal at an ordinary temperature.
- At low temperatures, the response speed of the liquid crystal display tends to become slower. But this is a natural character of the liquid crystal and it does not

mean anything wrong.

4. Battery note

- Though battery performance will generally be reduced by low temperatures, it will return to normal at an ordinary temperature. If you are shooting in cold weather, be sure to use new batteries and keep spare batteries on hand and, while warming them in a pocket, use these batteries alternately. If the battery power is low, the camera may will not operate at low temperatures.
- If the Battery Sign (⚡) switches to the Battery Low Sign (⚡), you should change the batteries soon. Take spare batteries along with you.
- Never dismantle the batteries, heat, throw into fire, charge or cause them to short circuit.

5. Storage precautions

- In hot weather, do not leave your camera in a closed compartment of your car, or on an ocean beach and in moist places except temporarily for a very short time.
- Keep the camera where it will be safe from moisture, heat, and dust. Be sure to put the lens cap on the lens.
- Do not store it in a wardrobe drawer because the gas of naphthalin or other insecticides can cause damage to the camera and film.

6. Film loading and unloading

- Always load and unload film in subdued light.

SPECIAL FEATURES

● A fully automatic, 6 × 4.5cm format autofocus camera

- ① Super EBC Fujinon 1:4, f=60 mm lens / 1:4 f=45 mm lens promise sharp and clear pictures with high image quality.
- ② Hybrid autofocus system (passive type with external light and active type with infrared rays) backs up the Super EBC Fujinon lens to bring its high performance into full play.
- ③ A variety of exposure techniques are provided, such as programmed auto exposure that frees you from the trouble of exposure settings, aperture-priority auto exposure, manual exposure for experienced photographers, and fractional exposure control capable of responding to various lighting conditions.
- ④ Automatic, pop-up type built-in flash is simple to use and saves energy on serial control. Its charge-up time is short and the batteries last long.
- ⑤ One-touch pressure plate switchover enables you to use both 120 and 220 roll films (automatic focal-plane adjustment, automatic counter switchover, and display of the film type on the LCD panel).
- ⑥ Motorized film winding and automatic first-frame positioning makes it as easy to operate as 35mm cameras because it is not necessary to position the start mark.
- ⑦ Built-in exposure data printing unit enables you to store your exposure techniques. The date (Year Month

Day) and time (Day Hour Minute) can also be printed (outside the picture frames).

- ⑧ LCD panel on the camera top lets you check the camera's operating conditions at a glance.
- ⑨ Major shooting modes can be switched easily with a large-size select dial which shows you camera functions clearly.
- ⑩ Thin body with a collapsible lens mount.

SPECIFICATIONS

The descriptions in parenthesis [] are for GA645W.

● Type

Fully automatic, 6 × 4.5cm format autofocus camera

● Picture Size

6 × 4.5cm format (actual picture size: 56 × 41.5mm)

● Film

120 (16 exposures) and 220 (32 exposures) roll film.

● Lens

Super EBC Fujinon 1:4 f=60mm lens (6 components, 7 elements), equivalent to 37mm on 35mm format, 60° angle of view [Super EBC Fujinon 1:4 f=45 mm lens (5 components, 7 elements), equivalent to 28 mm on 35 mm format, 75° angle of view], 0.7m minimum focusing distance, 52mm filter diameter.

● Focusing

Hybrid (active type and passive type) autofocus system, 0.7m – ∞ focusing range, switchable to manual focusing mode, provided with focus lock.

- **Finder**
Illuminating window type bright frame finder, automatic parallax correction, 93% [90%] field of view at infinity, 93% [90%] at 3m, 91% [90%] at 1.0m, 0.5X [0.38X] magnification.
- **Display in the Finder**
Picture frame (bright frame), autofocus sign, data display: aperture value, correct-exposure sign (\blacklozenge), shutter speed, flash activation, shooting distance (distances in feet can also be displayed), distance unit (m).
- **Shutter**
Electronic, programmed auto-exposure interlens shutter (exposure settings on aperture-priority auto exposure and manual exposure are also possible), provided with buzzer for indicating that the shutter has tripped.
- **Shutter Speed**
B, 2 sec. – 1/700 sec. (1/400 sec. at F4 – 9.5).
- **Self-timer**
Electronic self-timer with 10 sec. delay, provided with countdown lamp.
- **Exposure Control**
TTF (Through-the-Finder) center-weighted light metering (SPD photocell), programmed auto exposure, aperture-priority auto exposure, manual exposure, EV 3 – 19 coupling range (ISO 100).
- **Exposure Compensation**
 ± 2 EV in 1/2-step increments.
- **Film Speed Setting**
ISO 25 – 1600 in 1/3-step increments.
- **Flash**
Built-in, pop-up type flash, automatic control of amount of light, guide number 12 (ISO 100).
- **Film Advance**
Automatic first-frame positioning (alignment of start mark is not necessary), automatic winding, provided with buzzer for indicating the last frame, film is automatically wound up after the last frame is exposed.
- **Exposure Counter**
Additive type counter on liquid crystal display, interlocked with 120/220 pressure plate switchover, "E" sign appears after the last frame is exposed.
- **Liquid Crystal Display (LCD)**
Number of exposures, shutter speed, aperture, film speed, type of film (120 or 220), battery warning sign, flash activation sign, exposure compensation mode sign, self-timer mode sign, manual focusing mode sign, date and time (Year Month Day/Day Hour Minute), shooting distance, total shots indicator.
- **Data Printing**
Printing outside the picture frames, dates (Year Month Day/Hour Minute), exposure data (exposure mode, aperture, shutter speed, exposure compensating value, AF/MF).
- **Others**
Hot-shoe, film reminder slot, cable release socket, tripod socket, provision for switching on and off buzzer sound.
- **Power Source**

Two CR123A lithium batteries; about 3000 shots can be taken without flash, and about 600 shots with 50% flash (as tested according to Fujifilm's battery testing procedure).

- **Dimensions**

166 (W) × 110 (H) × 66 (D) mm. [166 (W) x 110 (H) x 70 (D) mm] (Dimensions when the lens barrel is retracted)

- **Weight**

815 g [835 g] (without batteries).

- **Accessories**

Camera soft case, neck strap, lens hood, soft case for lens hood, lens cap, batteries (two).

* Specifications and performance are subject to change without notice.

I. READYING THE CAMERA

LOADING THE BATTERIES

1. Open the battery compartment cover (Fig. 1)

Set the Selecting Dial to OFF and, with a coin, turn the Battery Compartment Cover Screw toward the arrow to open the Cover.

2. Insert the batteries (Fig. 2)

Insert the batteries in the Battery Compartment with the plus (+) and minus (–) ends correctly as illustrated inside the Cover, then close it by tightening it with a coin.

- Use two 3V CR123A lithium batteries.
- The camera will not operate unless the batteries are correctly loaded.
- Change the two batteries at the same time and always use new batteries. Do not mix new and old ones.

3. Check the batteries (Fig. 3)

While pressing in the Dial Lock Release, turn the Selecting Dial from OFF to "P" (or "A" or "M"). If the Lens moves out into shooting position, the batteries are loaded correctly.

4. Condition of batteries (Fig. 4)

- Indicator lights (Fig. 4-A)
 - Indicator lights (Fig. 4-B)
 - Indicator flickers (Fig. 4-C)
- ① The battery capacity is normal.
 - ② The battery capacity is low. Replace the batteries with new ones.
 - ③ Since the battery capacity is low, the shutter lock is applied. Replace the batteries with new ones.
- A pair of new batteries will provide power for taking about 3000 shots without flash, and about 600 shots when half of the pictures are taken with flash (as tested according to Fujifilm's battery testing procedure).

DISPLAY AND PRINTING OF DATA

- This camera incorporates a data printing unit which allows you to print the date, time, and exposure data outside the picture frames on your film.

1. Changing the data format

Data Format	Display on LCD (Example)	Printing (Example)
<pre> graph TD A[Printing off] --> B[Year Month Day] B --> C[Day Hour Minute] C --> D[Exposure Data] D --> E[Year Month Day/Exposure Data] E --> F[Year Month Day/Hour Minute] </pre>	<p style="text-align: center;">- - - - -</p> <p style="text-align: center;">'96 7 1</p> <p style="text-align: center;">115:35</p> <p style="text-align: center;">TV 125 4.0 Shutter speed → ← F-number</p> <p style="text-align: center;">'96 7 1 TV 125 4.0 ← Blinks alternately →</p> <p style="text-align: center;">'96 7 1 115:35 ← Blinks alternately →</p>	<p style="text-align: center;">'96 7 1</p> <p style="text-align: center;">1 15:35</p> <p style="text-align: center;">P F4 1/125 +0.5 EV AF</p> <p style="text-align: center;">'96 7 1 P F4 1/125 +0.5 EV MF</p> <p style="text-align: center;">'96 7 1 15:35</p>

After changing the batteries, the data format is initially set to " - - - - - " (printing off). Each time you press in the Data Button, the arrangement of data will change as shown above. If your desired format appears, stop operating it.

The display of the data in the format which you have set will turn on for five seconds after you remove your finger from the Button, then turn off. The [DATA] Sign in the LCD will remain on to tell you that the camera has been set to the data printing mode.

- * The data in the "Year Month Day/Exposure data" or "Year Month Day/Hour Minute" format will blink alternately because all these data elements cannot be displayed in the LCD at the same time.
- * If you have set an exposure compensating value (+/-EV) in the exposure compensation mode, the compensated values of aperture and shutter speed will be displayed.
- * The "bulb" Sign will appear.
- * The LCD will display the correct date (Year Month Day) up to the year 2025.

2. Display and printing of data (Fig. 5)

The data (dates or exposure data) in the format you have set will be printed outside the picture frames on your film. The exposure data that can be printed are the exposure mode, F-number, shutter speed, and exposure compensating value.

- * After changing the batteries, be sure to reset the data because the data (date, time, and exposure data) which have been set will disappear.

3. Setting the date (Fig. 6, 7)

- ① Press in the Selecting Dial Lock button.
- ② Set the Selecting Dial to "P" (or "A" or "M").
- ③ Press in the Data Button, and look at the LCD display to see Year Month Day.
- ④ Make the Year number blink by pressing in the Autofocus Button.

- ⑤ Set the Year number (blinking) correctly with the Up/Down Dial.
- ⑥ Press in the Autofocus Button to complete the Year setting. The next number (Month) will blink. Set the number correctly as described in ⑤. Finally, set the correct Day in the same way.
- After setting the date, press in the Data Button to show the time (Day Hour Minute).

4. Setting the time (Fig. 8)

- ① Make the Hour number blink by pressing in the Autofocus Button.
- ② Set the Hour number (blinking) correctly with the Up/Down Dial.
- ③ Press in the Autofocus Button to complete the Hour setting. The Hour is displayed and printed on the 24-hour system.
- ④ Set the correct Minute as described above.
- ⑤ Press in the Autofocus Button twice. When it is pressed in for the first time, the Minute number will turn on and the " : " Sign will blink, which means that time setting has not yet been completed. When it is pressed in for the second time, the " : " Sign will stop blinking and glow, indicating that the setting operation has been completed.
- ⑥ After setting all numbers, select the data printing mode by pressing in the Data Button.

ATTACHING THE ACCESSORIES

1. Attaching the neck strap (Fig. 9)

- Anti-loosening Ring (Fig. 9-A)
- Buckle (Fig. 9-B)

- ① Pass both ends of the strap through the camera's Strap Lugs.
 - ② Adjust the strap length with the Buckles.
- When you pass the strap through the Strap Lugs, slide the Anti-loosening Rings. The strap ends will pass through them easier.

2. Using the soft case (Fig. 10)

Use the Soft Case when carrying the camera about or putting it away. It is a good protection against dust, dents and scratches.

- A semi-hard case is also available as an optional accessory.

3. Putting on the lens cap (Fig. 11)

To prevent accumulating dust and debris on the lens glass, put the lens cap on as soon as you are through taking pictures. To clean the lens, refer to "Cleaning the lens" on page 13.

- Be sure to remove the Lens Cap before taking pictures.

4. Putting on the filter and lens hood (Fig. 12)

- Indicator (Fig. 12-A)

The filter is mounted by screwing it into the front of the

lens barrel.

[GA645]

The lens hood is mounted by screwing it into the front of the lens barrel.

[GA645W]

The lens hood is mounted by placing the indicator on the lens hood upward as shown in the figure, putting the hood into the front of the lens barrel and turning it to the right till it is locked.

- Please use the respective hood for the respective camera. If the hood for GA645 is used on GA645W, an eclipse will be made on pictures.
- Use commercially available filters (filter diameter 52mm). Do not put on two or more filters because light may fall off along the picture edges or the autofocus beam may be blocked, making correct focusing impossible.
- When taking pictures by using filters with exposure factors, exposure compensation is necessary.
- Be sure to use the lens hood that comes with your camera. If you are using other hoods, we cannot guarantee correct focusing because light entering the Autofocus Window may be blocked.

5. Attaching the viewfinder eyepiece (Fig. 13)

The viewfinder eyepiece that comes with your camera has a -1.0 diopter. If you cannot focus clearly through the viewfinder, four optional eyesight adjustment lenses (the same as those for the FUJIFILM GW series) are available

+2D, +0.5D, -2.5D and -4D diopters).

Generally, if you are near-sighted, use an eyesight adjustment lens with a minus diopter, and if you are far-sighted, use one with a plus diopter.

LOADING THE FILM

1. Open the camera back (Fig. 14)

To open the Camera Back, shift the Camera Back Lock and press it down toward the camera bottom.

To close it, keep the lock shift, press the Camera Back gently against the body, then snap the lock down.

The Camera Back will not close with the Camera Back Lock snapped down. **Be careful, however, because the camera back lock key will be damaged if you close it strongly with the lock down.**

2. Check the position of the pressure plate (Fig. 15)

The position of the Pressure Plate changes with the type of film (120 or 220). Make sure that the Pressure Plate Positioning Pin is set to the type of film you are using.

If it is not, adjust so that it is set to the type of film you are using while pressing down the Pressure Plate with your fingers.

The film type indicator in the LCD will show you which type of pressure plate you have set. The Exposure Counter will also operate in accordance with the type of film you are using.

* For the protection of the lens, it is recommended that

the Selecting Dial be in the off position when loading film.

Results of exposure with wrong positions of the pressure plate

Position of Pressure Plate	Type of Film Loaded	Results of Exposure
120	220	<ul style="list-style-type: none"> ● Blurred pictures at full aperture or near it. ● A buzzer sounds after the 15th exposure. The film is wound back after the 16th exposure.
220	120	<ul style="list-style-type: none"> ● Blurred pictures at full aperture or near it. ● The buzzer does not sound after the 15th exposure. ● Although it depends on the film you are using, in most cases the film will be wound back after the 16th exposure.

* Please be careful, as blurred pictures will be made, if the pressure plate is set near the intermediate position.

3. Type of Film and number of exposures

- 120 roll film: 16 exposures
- 220 roll film: 32 exposures
- While 120 roll film is attached to an opaque backing paper over its entire length, such paper is used only on the ends of 220 roll film as leader. The thickness of the backing paper causes a shift in the position of the focal plane and the pressure plate adjusts for this difference while keeping the film flat on the focal plane. Check to make sure, therefore, that the Pressure Plate is set to the correct position for each type of film.

4. Press in the spool shaft buttons (Fig. 16)

Pop out the Spool Loading Knob and Film Loading Knob by pressing in the Spool Shaft Buttons on both sides.

- The empty spool is set in the Take-up Chamber, at the time of purchase.

5. Replace the empty spool (Fig. 17)

Take out the empty spool, fit it into the Take-up Chamber (on the right side), then press in the Take-up Spool Knob.

6. Insert the film (Fig. 18)

Insert the film in the Film Chamber (on the left side), then press in the Film Loading Knob.

- * The Take-up Spool and roll film can be loaded easier by fitting in the top side (camera top) first, then pressing in the bottom side.

7. Pull out the leader paper (Fig. 19)

- ① Pull out the film leader paper and pass it through the film channel.
 - ② Insert the tip into the slot of the take-up spool.
- When inserting the tip, adjust the position of the spool slot by turning the Up/Down Dial toward the arrow so that it fits smoothly into the slot.

8. Wind the leader paper (Fig. 20)

- Line up the start mark with this pin. (Fig. 20-A)

Wind the leader paper around the take-up spool by turning the Up/Down Dial toward the arrow. If you are using 120 roll film, wind it until you see the film start mark on the left side. Do not wind it any more. If you are using 220 roll film, wind it in by about 3 – 5 turns (about 15cm) around the spool.

- To prevent the roll from slackening press down the leader paper at the left side, and, applying tension, wind the leader paper securely around the Take-Up Spool.
- If you wind the film by only 1 – 2 turns around the Spool and close the Camera Back, the roll will slacken.
- * Exact positioning of the start mark is not necessary because the film tip is detected by the Film Sensor. Be careful, however, because correct first-frame positioning is not possible if you wind it in too much until the start mark comes to the right side of the picture frame.

9. Position the film for the first shot (Fig. 21)

- ① Close the Camera Back.

- > While pressing down the Select Dial Lock Button, set the Selecting Dial to either "P", "A" or "M". The film will automatically advance and position itself for the first shot, and the Lens will move out into shooting position.
- > If the Selecting Dial has already been set to "P", "A" or "M", press down the Shutter Release. The film will automatically advance and position itself for the first shot.
- > If the first frame is positioned, the Exposure Counter will show "1".

Tear off the top of your film box and insert it in the Film Reminder Slot in the Camera Back. It will remind you which film you are using.

3. Set the film speed (Fig. 22)

- > While pressing in the Dial Lock Release.
 - > Set the Selecting Dial to "ISO".
 - > Turn the Up/Down Dial until the film speed number (ISO) of the film you are using appears in the LCD.
- The setting range of film speeds is from ISO 25 to 1600 in 1/3-step increments.

II. BASIC PROCEDURES

TAKING AUTOMATIC-MODE (AUTOFOCUS/PROGRAMMED AUTO EXPOSURE/AUTOMATIC FLASH) PICTURES

- If you set the camera to the automatic modes, you can take pictures very easily.

1. Set the camera to the programmed auto exposure mode (Fig. 23)

While pressing in the Dial Lock Release, set the Selecting Dial to "P". The camera is set to the programmed auto exposure mode, in which the aperture and shutter speed are automatically set according to the brightness of the subject.

- The programmed exposure diagram on page 36 shows the coupling ranges of aperture and shutter speed in the programmed auto exposure mode.
- When taking pictures without flash in the programmed auto exposure mode, caution is required because camera shake is easier to occur with a shutter speed lower than 1/45 sec.

2. Check the autofocus (Fig. 24)

Make sure that the Manual Focusing Mode Sign (MF) does not appear in the LCD. If it does, turn it off by pressing in the Autofocus Button.

- If the "MF" Sign does not appear, it means that the

camera is set to the autofocus mode.

- If the "MF" Sign appears, it means that the camera is set to the manual focusing mode (see page 32).

3. Ready the flash (Fig. 25)

Pop up the flash Head by pressing in the Flash Button. If the camera is set to the programmed auto exposure mode, the Flash will not fire in bright light. It will automatically fire in dim light.

* For details on flash photography, refer to page 28.

4. Display in the finder (The figure below shows all markings displayed in the finder) (Fig. 26)

- ① Field-of-view frame (for distant objects) (Fig. 26-A)
- ② Field-of-view frame (for near objects) (Fig. 26-B)
- ③ Field-of-view frame (fixed) (Fig. 26-C)

You will get in your picture the area seen inside the frame ① or ③. The top and left sides of the finder frame ① will move to the position of ② with the shooting distance to automatically correct for parallax.

④ Autofocus spot (Fig. 26-D)

—+— Aim at the desired object by positioning it in the dotted circle (center of the cross mark).

The Lens will focus on your subject at which the autofocus spot is aimed.

⑤ F-number (Fig. 26-E)

Blinks if it is not suited for correct exposure.

⑥ Over or underexposure sign (Fig. 26-F)

If the exposure is correct, you will see neither the over

nor the underexposure sign.

The sign "▲" will appear in case of overexposure, and the sign "▼" in case of underexposure.

⑦ Shutter speed (Fig. 26-G)

The Sign ["] will turn on if the shutter speed is slower than 0.7 sec. The "bul" Sign will turn on during bulb exposure.

⑧ Flash Sign (Fig. 26-H)

If it turns on, the flash will fire.

⑨ Distance (Fig. 26-I)

The following table shows the approximate shooting distances displayed in the Finder as a guide. In the case of distances in meters, the letter "m" will be displayed together.

Display of Shooting Distance

Meters	0.7 m	0.8 m	0.9 m	1.0 m	1.1 m	1.2 m	1.5 m
Feet		2.3	2.5	3.0	3.5	4.0	5.0

1.7 m	2.0 m	2.5 m	3.0 m	5.0 m	10 m	INF
6	7	8	10	15	30	INF

* The Finder (and the LCD panel on the body) show, as a guide, the approximate distances in 14 steps. Actually, the camera's autofocus system sets the shooting distances in 870 steps and drives the lens according to the set distance.

* In the case of distances in feet, the "Ft" Sign will not be displayed in the Finder.

Refer to page 33 for instructions on how to switch the unit of distances which are displayed.

4. Holding the camera (Fig. 27)

- Taking vertical-position pictures (Fig. 27-A)
- Taking horizontal-position pictures (Fig. 27-B)

Hold the camera still and keep your hand or fingers away from the Autofocus Window.

If the Autofocus Window is blocked by the hand or fingers, you will get fuzzy pictures because correct focusing is not possible.

To take horizontal-position pictures, hold the camera with the Camera Grip on the bottom side.

If you take horizontal-position pictures with the Camera Grip on the top side, caution is required because the shadow of the lens hood will fall partly on the Autofocus Window in toplighted or semi-backlighted conditions, causing a focusing error on autofocus.

5. Compose your picture (Fig. 28)

- ① Aim at the desired object by the AF mark (within the scope of AF distance measurement).
 - ② Press the Shutter Release about halfway down, hold it there and check the display in the Finder.
- When the object you aim at is out of the AF mark, shoot using focus lock. For further information on focus lock turn to Page 31.

7. Check the exposure (Fig. 29)

- ① If you see neither the Overexposure (▲) nor the Underexposure (▼) Sign in the Finder, you will obtain correct exposure.
- ② If the Underexposure Sign (▼) turns on and both the F-number and shutter speed blink, the camera cannot set correct exposure within its coupling range, and your picture will be underexposed.
- ③ If the Overexposure Sign (▲) turns on and both the F-number and shutter speed blink, the camera cannot set correct exposure within its coupling range, and your picture will be overexposed.
- ④ If the Flash Sign (⚡) turns on, it tells you that the Flash will fire automatically.
 - Blinking (Fig. 29-A)

8. Check the shooting distance (Fig. 30)

- Blinking (Fig. 30-A)
- ① If the distance number turns on, the camera has completed focusing and set the correct distance.
 - ② If "0.7m" blinks, you are too close to your subject. Move back to a distance of 0.7m or more.
- If the displayed distance on autofocus differs greatly from that estimated with your eyes, the cause may be that the Autofocus Spot is off your subject. Focus again by aiming the Autofocus Spot correctly at your subject.
- ③ If "InF" (infinity) blinks, use manual focusing or Focus Lock because correct focusing is not possible. (For details, refer to the paragraph on the autofocus on

Page 34.)

- If the Shutter Release is depressed with the "InF" Sign blinking, the Lens will focus on infinity.
- When the distance indicator flickers all the time, your camera is in the MF (manual focus) mode. Set it to the AF mode. (Refer to Page. 23.)

9. Trip the shutter (Fig. 31)

Press the Shutter Release about halfway down and check the composition, distance and exposure. If they are good, take your picture by gently pressing the Shutter Release all the way down. When the shutter trips, an electronic buzzer "beep" will sound.

10. When the last frame is reached (Fig. 32)

If the film is positioned for the last shot, an electronic buzzer will sound six times to tell you that the film has reached the last frame.

- * When using the cable release, this halfway-down mode is not possible. Be careful to make one positive shutter pressing to operate the distance, exposure and shutter tripping.
- * If the sound of the electronic buzzer is worrisome, you can switch it off. For details, refer to "Extra functions" on page 33.

UNLOADING THE FILM

1. Exposing the last frame and unloading the film (Fig. 33)

After exposing the last frame, the film will automatically wind itself up to the very end and the letter "E" will appear in the LCD.

Make sure the "E" Sign appears in the LCD, then open the Camera Back and take out the exposed film.

To prevent the film from loosening, seal it tightly with the End Seal.

2. Unloading the film in mid-roll (Fig. 34)

Press in the Mid-roll Wind-up Button on the camera bottom. The film will wind itself up to the very end then stop. When winding is completed, the "E" Sign will appear in the LCD.

III. ADVANCED TECHNIQUES

APERTURE-PRIORITY AUTO EXPOSURE

1. Set the Selecting dial to "A" (Fig. 35)

If you set the Select Dial to A, while pressing down the Select Dial Lock Button, your camera will be set to the aperture-priority AE mode.

2. Set the aperture (Fig. 36)

Turn the Up/Down Dial until your desired aperture ap-

appears in the LCD. The aperture is stopped down by turning the Dial counterclockwise.

- The aperture will be displayed in 1/2-step increments.

Step	F-number
1 step	4.0 5.6 8.0 11 16 22
1/2 step	4.8 6.7 9.5 13 19

3. Press the shutter release about halfway down (Fig. 37)

Aim your subject and press the Shutter Release about halfway down. The aperture you have set and the shutter speed suited for it will be displayed in the Finder and LCD. If you change the aperture, the shutter speed will change automatically. The upper limit of the shutter speed that can be set differs with the aperture as shown below.

F4 – F9.5 : 1/400 sec.

F11 – F22 : 1/700 sec.

4. Check the display in the finder (Fig. 38)

Press the Shutter Release about halfway down.

- ① If neither the Overexposure (▲) nor the Underexposure (▼) Sign turns on, you will obtain correct exposure.
- ② If the shutter speed blinks and the Overexposure Sign (▲) turns on, the correct shutter speed suited for the aperture you have set is not within the camera's cou-

pling range, and your picture will be overexposed. Stop down the aperture.

- ③ If the shutter speed blinks and the Underexposure Sign (▼) turns on, your picture will be underexposed. Open up the aperture or use flash.
- In the case of incorrect exposure in ② and ③, the shutter speed in the LCD will also blink.

MANUAL EXPOSURE

1. Set the selecting dial to "M" (Fig. 39)

- If you want intentional over or underexposure to take high-key or low-key pictures, use manual exposure.
- This mode can also be used to set exposure for backlit subjects or other subjects for which correct exposure cannot be obtained in the "P" or "A" mode.

When the Select Dial is set to M, while pressing down the Select Dial Lock Button, the "TV" sign will appear in the LCD to inform you that the camera has been set to the manual exposure mode.

2. Set the shutter speed (Fig. 40)

While pressing in the Exposure Compensation Button (+/-) set the shutter speed with the Up/Down Dial. When the Exposure Compensation Button is depressed, the "TV" Sign will blink.

- If the camera is set to the manual exposure mode, the Exposure Compensation Button (+/-) can be used for setting the shutter speed, but not for exposure compen-

sation.

3. Set the aperture (Fig. 41)

Set the aperture by turning the Up/Down Dial.

- If the shutter speed is set for bulb exposure, the "bul" Sign will appear both in the Finder and LCD. During bulb exposure, no battery power is consumed so you need not worry that the batteries may run out during long-time exposure.
- At bulb exposure, the shutter remains open while the shutter button is held pressed.

4. Adjust the shutter speed and aperture (Fig. 42)

- Correct-exposure Sign (Fig. 42-A)
- Overexposure Sign (Fig. 42-B)
- Underexposure Sign (Fig. 42-C)

Press the Shutter Release about halfway down. If the Correct-exposure Sign (◆) appears in the Finder, the exposure is correct. If the Over (▲) or Underexposure (▼) Sign appears, adjust the aperture or shutter speed so that the (◆) Sign turns on.

- If you want intentional over or underexposure, take pictures with the Over (▲) or Underexposure (▼) Sign displayed in the Finder.

USING THE BUILT-IN FLASH

1. Readyng the flash (Fig. 43)

- ① Pop up the Flash Head by pressing the Flash Button.

- ② As soon as the Flash Sign (⚡) in the LCD stops blinking and glows, the flash is ready to fire.

- The Flash Sign (⚡) will blink while the flash is charging. While it blinks, the camera's operating functions such as releasing the shutter will not work.
- The table shows the minimum exposure (allowable aperture) depending on the ISO value, due to the limitation of flash control capabilities.

ISO	25	50	100	200 or more
Minimum exposure	8	11	16	22

2. Exposure control with the built-in flash (Fig. 44)

- Flash Sensor (Fig. 44-A)

The camera's built-in flash operates as an automatic flash which measures the intensity of the light reflected by the subject and automatically adjusts its amount of light in accordance with the aperture which is set. A flash sensor which receives the light reflected from the subject measures the amount of light in the center of the picture frame.

- In the aperture-priority auto exposure or manual exposure mode, the flash will always fire. It can be used as fill-in light when shooting your subject in the shade of a tree or for obtaining a catch-light effect on portraits.

3. Exposure modes and flash operation

Exposure Mode	Flash Pop-Up	Aperture	Shutter Speed	Exposure Compensation (Stationary Light)
Programmed AE	No flash firing	Automatic control		Possible
	Automatic firing in low light	F4	1/45	Not possible
Aperture-priority AE	Always fires	Set aperture	Automatic control	Possible
Manual exposure			Set shutter speed	—

- ① Programmed auto exposure: The flash will fire automatically in low light (refer to the programmed exposure diagram on page 36).
 - ② Aperture-priority auto exposure: The flash will always fire. The amount of light of the flash and the shutter speed will change with the aperture which is set. The shutter speed will be quite slow in a dark place, so be careful to hold the camera steady and avoid taking moving objects.
 - ③ Manual exposure mode: The flash will always fire and the flash will adjust its amount of light according to the aperture which is set. The shutter will trip at the set shutter speed.
- It is not possible to compensate for the amount of light generated by the flash.

4. Control range

Film speed (ISO)	25	50	100	160	200	400	800
Guide number	6	8.5	12	15	17	24	34
Farthest flash distance (m)	1.5	2.1	3	3.8	4.3	6	8.5
Nearest flash distance (m)	0.7						

The guide number of the built-in flash (with the maximum amount of light) is 12 at ISO 100. It will increase by 1.4 times if the film speed (ISO) becomes double, and double if the guide number increases four times.

- The farthest flash distance is calculated by dividing the guide number by the lens F-number at full aperture (F4 with this camera).

$$\text{Flash distance} = \frac{\text{Guide number}}{\text{F-number}}$$

If the camera is set to the aperture-priority auto exposure mode, calculate the maximum flash distance with the aperture being set.

- Because negative films have a wider exposure latitude, the flash ranges are longer than those in the above table.

USING AN EXTERNAL FLASH

1. Mount the flash (Fig. 45)

Attach a commercially available hot-shoe type external flash such as STROBE GA to the Hot-Shoe of the camera.

- Do not use flashes designed for cameras of other makers that have a signal pin because mounting and dismounting may become impossible.
- As the camera is set to the low speed shutter in a dark place in the A mode, blurred pictures are liable to be made. We recommend that you use your camera in the M mode.

2. Flash covering area (Fig. 46)

- Light fall-out (Fig. 46-A)
- External flash covering area (in the case of flashes with different vertical and horizontal covering angles) (Fig. 46-B)
- Covering area of 6 x 4.5 cm version (Fig. 46-C)
- Covering area of STROBE GA (Fig. 46-D)

In the case of an external flash with different vertical and horizontal covering angles (lighting features) the flash covering area and the direction of an image plane may not coincide.

To solve light fall-off we recommend that you use a commercially available STROBE GA.

EXPOSURE COMPENSATION

1. Set the exposure compensating value (Fig. 47)

If you want to take high-key or low-key pictures, use exposure compensation in the programmed auto exposure or aperture-priority auto exposure mode.

① While pressing in the Exposure Compensation Button (+/-), ② turn the Up/Down Dial. ③ The exposure compensating value will be displayed in the LCD in 0.5 EV-step increments. The compensating range is ± 2 EV.

2. Display of the compensating value (Fig. 48)

If you press in the Exposure Compensation Button (+/-) after setting the compensating value, only the "  " Sign will be displayed to tell you that the camera is set for exposure compensation. If you then press the Shutter Release

about halfway down, the compensated values of aperture and shutter speed will be displayed.

- * The exposure compensating value once set is retained. Be careful when using the camera next time to reset as required.

USING THE FOCUS LOCK

1. A word on the focus lock (Fig. 49)

If the Autofocus Spot is off your subject, the Lens will not focus on it. Move the camera slightly, aim the Autofocus Spot at your subject to focus on it, then recompose your picture by moving the camera back to its original position.

2. There are two methods (Fig. 50)

There are two methods of focus lock. In either method, activate the Focus Lock with the camera set to autofocus (there is no "MF" Sign in the LCD).

- ① Using the Shutter Release only
Use this method if the exposure does not change when you change the picture composition.
- ② Using the Manual Focusing Button
Use this method if the exposure changes substantially when you recompose your picture — if the object at which the Autofocus Spot is aimed has a great difference in brightness, for example.

■ When using the shutter release only

1. Press the shutter release about halfway down (Fig. 51)

Aim the Autofocus Spot at your main subject, press the Shutter Release about halfway down to lock the focus and hold it there.

2. Compose your picture and trip the shutter

While holding the Shutter Release about halfway down, recompose your picture and take it by depressing the Shutter Release all the way.

- * If the camera is set to auto exposure (programmed or aperture-priority auto exposure mode), the exposure will be determined for the picture you composed with the Shutter Release halfway down (focus locked).

■ When using the manual focusing button

1. Press the shutter release about halfway down (Fig. 52)

Aim the Autofocus Spot at your subject and press the Shutter Release about halfway down. While holding it there, keep on pressing the Manual Focusing Button.

2. Compose your picture and trip the shutter

With the Manual Focusing Button in depressed position, compose your picture then remove your finger from the Shutter Release to lock the focus. Keep on pressing the Manual Focusing Button, recompose your picture and trip the shutter.

- * In the programmed or aperture-priority auto exposure mode, if the Manual Focusing Button is depressed, the exposure is determined when the Shutter Release is

pressed about halfway down.

- * If you press the Shutter Release about halfway down again, the distance set by the focus lock will blink, indicating that the focus lock is operating. Once you remove your finger from the Manual Focusing Button, the focus lock will be canceled.
- * This method is useful for taking successive shots on pan focus, which enables you to utilize the depth-of-field effect centering around the subject that has been focused by the autofocus system.

MANUAL FOCUSING

1. Set the manual focusing mode (Fig. 53)

Press in the Autofocus Button. The "MF" Sign will be displayed in the LCD to tell you that the camera is set to the manual focusing mode. If you press in the Autofocus Button again, the camera will return to the autofocus mode.

2. Set the distance (Fig. 54)

Press in the Manual Focusing Button, hold it there and set the distance with the Up/Down Dial.

- * The "MF" Sign will blink when the Manual Focusing Button is depressed. You can set the distance only when it is blinking.
- * When the Manual Focusing Button is depressed in the manual focusing mode, the distance is initially set to 2.0 m.
- * The distances that can be manually set are shown in

"Display in the finder" on page 24.

3. Effective uses of the manual focusing mode

- ① If you want to have another person take a picture of yourself

Set the shooting distance beforehand, hand over the camera to another person and ask him (or her) to depress the Shutter Release. You need not explain him (or her) how to aim the subject with the Autofocus Spot.

- ② If you want to take a moving object by pan focus

If you have set the shooting distance in advance by using the manual focusing mode, the time lag caused by a lens drive on autofocus is eliminated. With the aperture stopped down (to F8 – F11), the lens will exhibit its pan-focus effect to enable you to take quick shots.



- ③ If you want to minimize the time lag on shutter operation

All-automatic cameras require some time for the distance measurement and lens drive. If you set the camera in the following manner, the time lag from the moment you depress the Shutter Release to the moment the shutter trips will be minimized to let you take pictures successively.

- i) Depending on the subject, set the distance by manual focusing.
- ii) Press the Shutter Release about halfway down and move the lens to the set distance in advance.
- iii) Set the aperture to F9.5 by using the aperture-priority auto exposure or manual exposure mode.

USING THE SELF-TIMER

1. Set the self-timer mode (Fig. 55)

To set the self-timer mode, press in the Self-timer Button () to bring out the Self-timer Sign () in the LCD.

2. Start the self-timer (Fig. 56)

To start it, press down the Shutter Release. The Self-timer Lamp will turn on and the Self-timer will start. The Lamp will glow for seven seconds, then blink for three seconds, after which the shutter will trip to take your picture.

* After shooting with the Self-timer, the self-timer mode will be switched off. To take a picture with the Self-timer again, press in the Self-timer Button a second time.

* In the self-timer mode, the camera's autofocus and auto exposure system will operate when the Shutter Release is depressed. Depending on the subject conditions, use manual focusing and manual exposure for compensating for autofocus, intensifying or reducing the subject contrast, etc.

IV. EXTRA FUNCTIONS

1. Switchover of the distance unit (Fig. 57)

- Distance unit in meters (Fig. 57-A)
- Distance unit in feet (Fig. 57-B)

The distance unit can be switched from meters to feet, or vice versa.

Your camera is Factory-set to display the distances in

meters and the letter "m" will be displayed beside the distance number in the Finder and LCD.

To switch to "feet", press in the Autofocus Button, hold it there and turn the Selecting Dial from OFF to "ISO". The "Ft" Sign will be displayed for five seconds in the LCD, but not in the Finder.

To reset the distance unit to "m", repeat the above-mentioned procedure. The LCD will show "m" for five seconds to tell you that the resetting operation has been completed.

2. Switching off the buzzer (Fig. 58)

- Buzzer on (Fig. 58-A)
- Buzzer off (Fig. 58-B)

If you feel the buzzer sound worrisome, you can switch it off.

An electronic "beep" which sounds when the shutter tripped, or a repeated "beep, beep, beep," which tells you that the film has reached the last frame can be switched off.

While pressing in the Self-timer Button, turn the Selecting Dial from OFF to "ISO". The "OFF" Sign will be displayed in the LCD for five seconds and the buzzer will turn off.

To reset it to "ON", repeat the same procedure. The LCD will show "ON" for five seconds to tell you that the buzzer has been switched on again.

3. Total shots indicator (Fig. 59)

Use it as a guide for regular maintenance.

- Indicates 3000 shots (Fig. 59-A)
- Always shows "00" (Fig. 59-B)

Press in the Exposure Compensation Button (\pm) and turn the Selecting Dial from OFF to "ISO". While pressing in the Button, the Total Shots Indicator in the LCD will show you the total number of shots that have been taken. It will count the number in units of 100.

Use this function as a guide for overhauling or regular maintenance.

- Though new, some units will show that they have been factory-tested up to about 200 shots.

V. A WORD ON THE CAMERA'S AUTOFOCUS SYSTEM

■ Principle

Your camera's autofocus system uses an active type method (trigonometrical distance measurement with infrared rays) and a passive type method (detection of phase difference) for precise focusing.

While the passive type method takes care of distant objects that cannot be reached by infrared rays, the active type method takes care of low-contrast objects (at near distances) that are not suited for the passive type autofocus method, thereby increasing the reliability of the autofocus system to improve the focusing accuracy.

■ Objects that are not suited for autofocusing

In the following cases, the Lens may not be able to focus

on the subject or the displayed distance may differ extremely with the actual subject distance.

- Fast-moving objects.
- Objects that have no definite shape, such as smoke and flame (especially on active-type autofocusing).
- If you are shooting through a window glass.
- If your subject cannot reflect enough light, such as a bunch of hair and fur.
- Strongly reflecting objects, such as a mirror and car body (especially on passive-type autofocusing).
- Extremely low-contrast objects.
- Objects which have vertical lines only.

REFERENCE DATA

● Depth-of-field Table

Permissible circle of confusion: 0.05mm
(Distances in meters)

GA645

FNo. \ Shooting distance	0.7 m	1.0 m	1.2 m	1.5 m	2.0 m	3.0 m	5.0 m	10 m	∞
4.0	0.68 ~0.72	0.96 ~1.04	1.14 ~1.26	1.41 ~1.61	1.83 ~2.21	2.62 ~3.51	4.01 ~6.68	6.62 ~20.7	19.13 ~∞
5.6	0.68 ~0.73	0.95 ~1.06	1.12 ~1.29	1.37 ~1.66	1.77 ~2.30	2.49 ~3.78	3.70 ~7.78	5.82 ~37.4	13.56 ~∞
8.0	0.67 ~0.74	0.93 ~1.09	1.09 ~1.34	1.33 ~1.73	1.69 ~2.46	2.33 ~4.25	3.35 ~10.14	4.97 ~∞	9.63 ~∞
11	0.66 ~0.75	0.90 ~1.13	1.05 ~1.40	1.27 ~1.85	1.59 ~2.73	2.14 ~5.15	2.95 ~17.89	4.12 ~∞	6.84 ~∞
16	0.64 ~0.78	0.87 ~1.20	1.00 ~1.51	1.19 ~2.06	1.47 ~3.22	1.92 ~7.41	2.53 ~∞	3.33 ~∞	4.88 ~∞
22	0.62 ~0.82	0.82 ~1.31	0.94 ~1.70	1.10 ~2.45	1.33 ~4.37	1.67 ~20.1	2.11 ~∞	2.63 ~∞	3.48 ~∞

GA645W

FNo. \ Shooting distance	0.7 m	1.0 m	1.2 m	1.5 m	2.0 m	3.0 m	5.0 m	10 m	∞
4.0	0.67 ~0.74	0.93 ~1.09	1.09 ~1.33	1.33 ~1.72	1.70 ~2.44	2.36 ~4.16	3.40 ~9.58	5.11 ~436.5	10.23 ~∞
5.6	0.66 ~0.75	0.90 ~1.13	1.06 ~1.39	1.28 ~1.83	1.61 ~2.66	2.18 ~4.90	3.04 ~14.96	4.31 ~∞	7.41 ~∞
8.0	0.64 ~0.78	0.87 ~1.19	1.01 ~1.49	1.20 ~2.02	1.49 ~3.10	1.96 ~6.70	2.62 ~94.46	3.50 ~∞	5.27 ~∞
11	0.62 ~0.82	0.82 ~1.29	0.95 ~1.67	1.11 ~2.36	1.35 ~4.05	1.72 ~14.10	2.20 ~∞	2.77 ~∞	3.76 ~∞
16	0.59 ~0.88	0.77 ~1.47	0.87 ~2.01	1.01 ~3.14	1.20 ~7.23	1.47 ~∞	1.80 ~∞	2.15 ~∞	2.69 ~∞
22	0.56 ~0.99	0.71 ~1.86	0.79 ~2.84	0.90 ~6.02	1.04 ~∞	1.22 ~∞	1.43 ~∞	1.65 ~∞	1.93 ~∞

● **Aperture and Shutter Speed Coupling Ranges**
 [Aperture-priority auto exposure and manual exposure
 (ISO 100)]

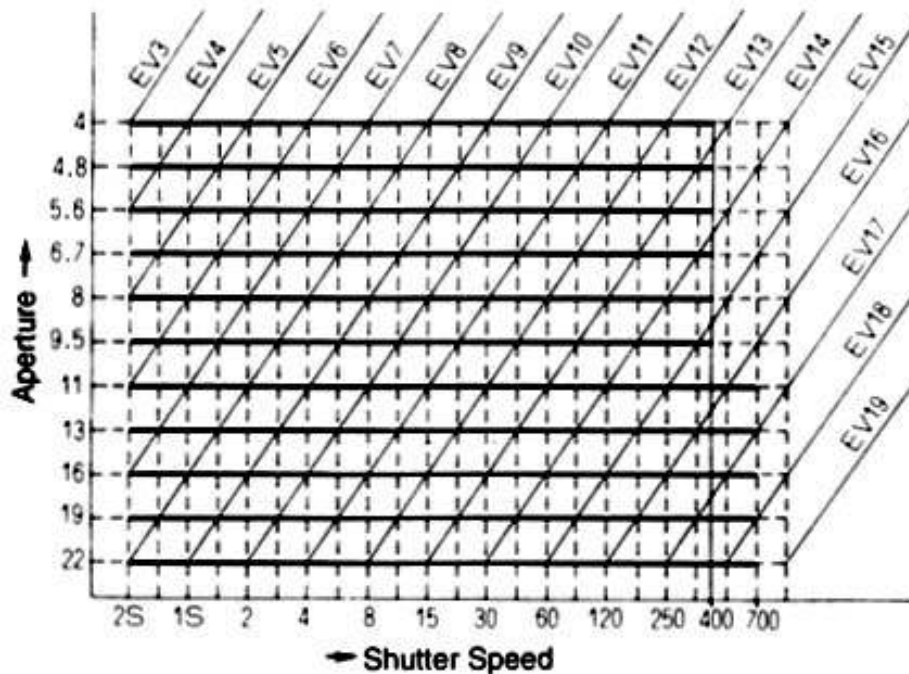

* When you take pictures against the light, caution is required because your picture will be underexposed if direct light enters the light receptor in the Finder.

● **Programmed Exposure Diagram**
 [Programmed auto exposure]

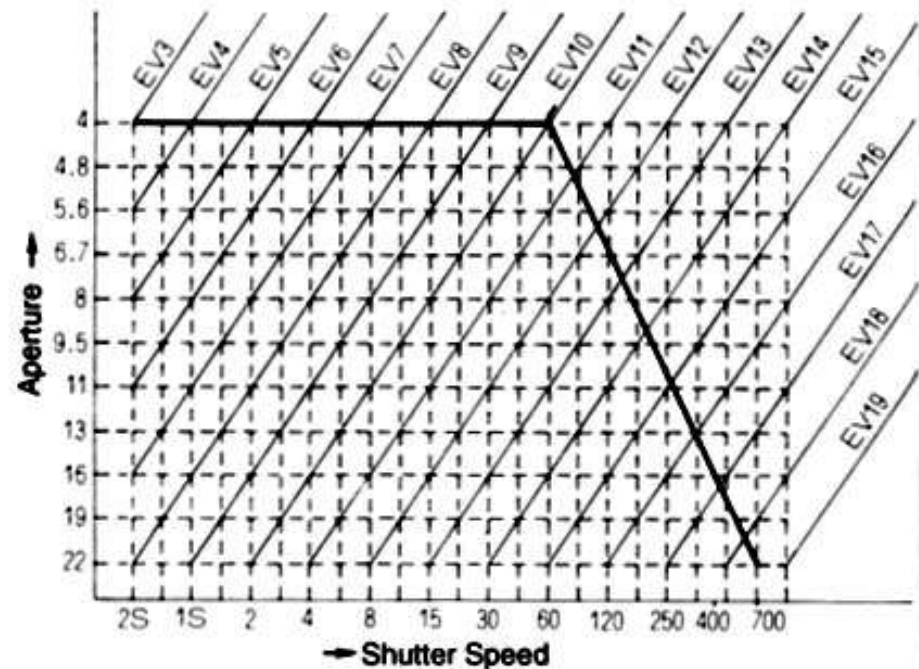

* The Flash will fire automatically in dim light by calculating its correct amount of light at F4 and 1/45 sec.



FUJI PHOTO FILM CO., LTD.

26-30, Nishiazabu 2-chome, Minato-ku, Tokyo 106, Japan.

< FUJIFILM ABROAD >

- In North America** **FUJI PHOTO FILM U.S.A., INC.**
555 Taxter Road, Elmsford, N.Y. 10523, U.S.A.
FUJI PHOTO FILM CANADA INC.
275 Britannia Road East, Mississauga, Ontario, L4Z 2E7, Canada
FUJI PHOTO FILM HAWAII, INC.
1650 Kalakaua Avenue, Honolulu, Hawaii 96826
- In Europe** **FUJI PHOTO FILM (EUROPE) G.m.b.H.**
Heesenstrasse 31, 40549 Dusseldorf, Germany
FUJI PHOTO FILM (U.K.) LTD.
Fuji Film House, 125 Finchley Road, Swiss Cottage, London NW3 6JH, England
FUJI FILM ESPAÑA, S.A.
Aragon, 180, 08011-Barcelona, Spain
- In South America** **FUJI PHOTO FILM DO BRASIL LTDA.**
Avenida Vereador Jose Diniz No. 3.400, Campo Belo - CEP 04.604
Cx. Postal 9.959., Sao Paulo-SP, Brasil
- In Asia** **FUJI PHOTO FILM CO., LTD., HONG KONG OFFICE**
Room 916, Sun Plaza, 28 Canton Road, Tsim Sha Tsui, Kowloon, Hong Kong
FUJI PHOTO FILM (SINGAPORE) PTE. LTD.
10 New Industrial Road, Singapore 536201
FUJI PHOTO FILM (THAILAND) LTD.
S.P. Building, 8th Floor, 388 Phaholyothin Road, Bangkok 10400, Thailand
FUJI PHOTO FILM (MALAYSIA) SDN. BHD.
Letter Box 3, 3rd Floor Office Block 1, Crystal Plaza Lot 4, Jalan 51A/223
46100 Petaling Jaya Selangor Darul Ehsan Malaysia
FUJI PHOTO FILM CO., LTD., TAIPEI OFFICE
Rm. 601, Hung Chong Bldg., No.38, Sec. 6, Min Chuan E. Rd., Taipei 11412, Taiwan, Republic of China
FUJI PHOTO FILM CO., LTD., SEOUL OFFICE
Sanduck Bldg. 6F., 144-1, Samsung-Dong, Kang Nam-Ku, Seoul 135-090, Korea
FUJI PHOTO FILM CO., LTD., BEIJING REPRESENTATIVE OFFICE
Beijing Fortune Bldg. No. 817, 5. Dong Sanhuan Bei-lu, Chaoyang District, Beijing, China 100004
FUJI PHOTO FILM CO., LTD., HO CHI MINH OFFICE
29-31 Ton That Thiep St., Q1 Ho Chi Minh City, Vietnam
- In Oceania** **FUJI PHOTO FILM CO., LTD., SYDNEY REPRESENTATIVE OFFICE**
c/o Hanimex Pty. Limited, Old Pittwater Road, Brookvale, N.S.W. 2100, Australia
- In Middle East** **FUJI PHOTO FILM CO., LTD., DUBAI OFFICE**
No. 4G-17, L. O. B. No. 4, Jebel Ali, Dubai, U. A. E.

Printed in Japan



This product is in conformity with Directive 89/336/EEC.
Dieses Produkt entspricht der Direktive 89/336/EEC.
Ce produit est conforme à la Directive 89/336/EEC.
Producto conforme con la Normativa 89/336/EEC.
本產品符合 89/336/EEC 指令。

Printed on recycled paper
Gedruckt auf wiederverwertetem Papier
Imprimé sur papier recyclé
Impreso en papel reciclado
本小册子使用再生紙印製

FGS-698006-FG